

# KEYENCE

**NEW** Color-Differentiating Fiberoptic Sensor  
CZ Series



R · G · B

Three-Light Source & High Precision

Featuring 3 light sources for advanced color differentiation and flexibility for installation in a variety of conditions

**CZ**  
SERIES

CE

# The CZ Series boasts separate RGB light sources for high-precision detection.

KEYENCE introduces two new models that brings the total to six fiber units that provide excellent color differentiation.

## CZ SERIES LINE-UP

### General-purpose area type ■ ■ ■ area spot type

By averaging values from an area spot, the sensor can absorb inter-sample variations such as the influence of detailed patterns or scratches on the workpiece surface to deliver stable, reliable detection.

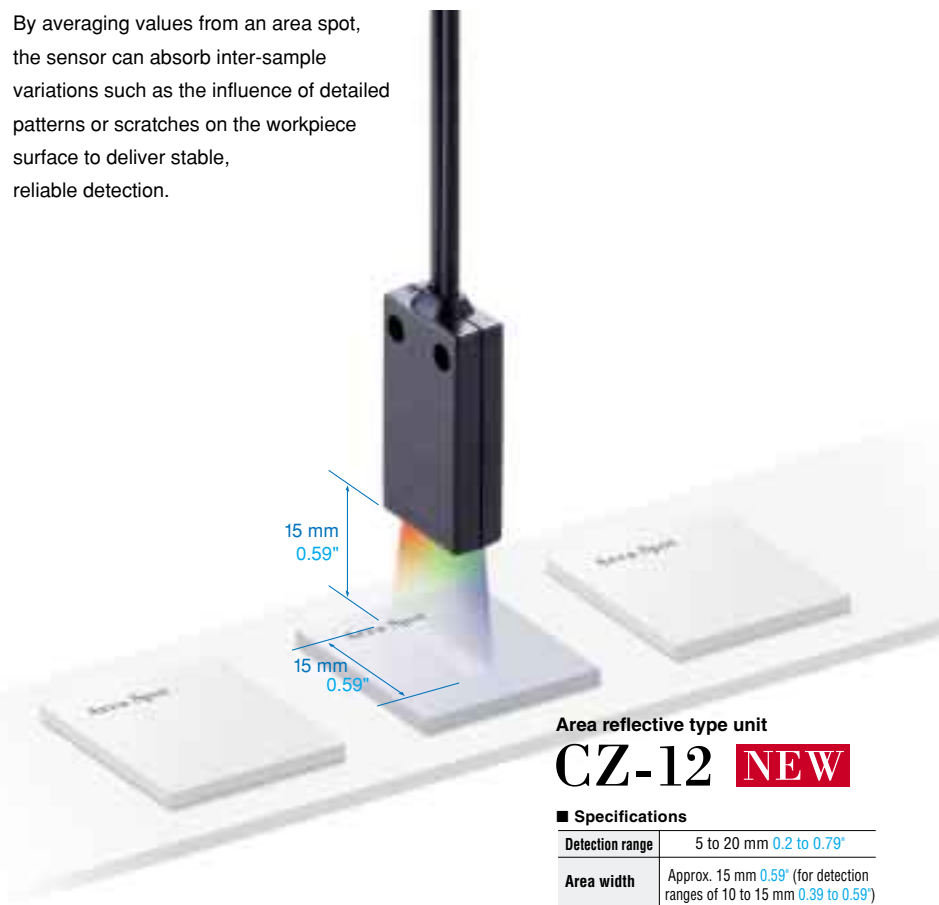

An area spot means stable, reliable detection capability.

#### Compatible with uneven workpiece surfaces.

When the beam spot is too small, some workpiece surface shapes make the light emitted by the fiber unit impossible to be received by causing it to reflect irregularly. The CZ-12 eliminates this problem, averaging light from a large area spot to enable stable detection.

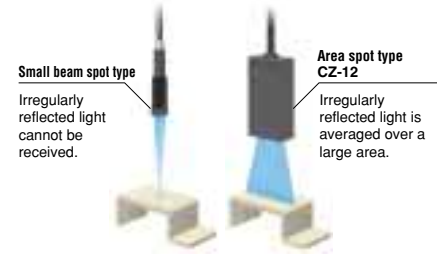

#### Compatible with variations in workpiece position.

With the CZ-12's area spot, workpieces can be detected even when there's a slight amount of variation in the position at which they pass the spot.

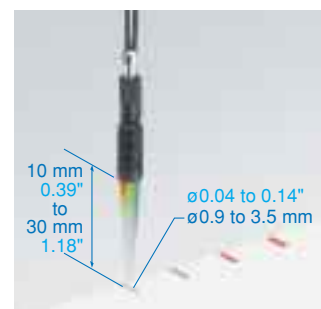
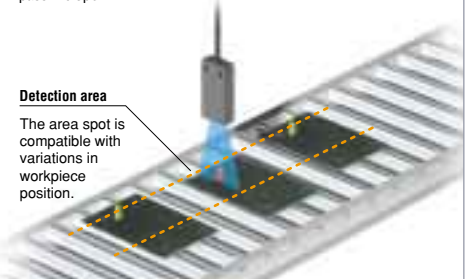

Adjust the size of the beam spot to fit the workpiece.

### Variable beam spot type CZ-10

#### Specifications

Detection range	10 to 30 mm 0.39" to 1.18"
Beam spot diameter	ø0.9 to ø3.5 mm ø0.04" to ø0.14"

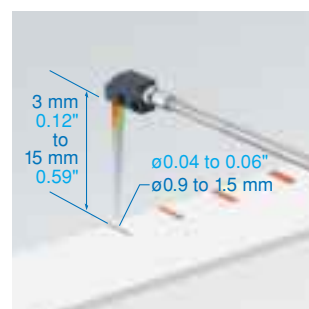
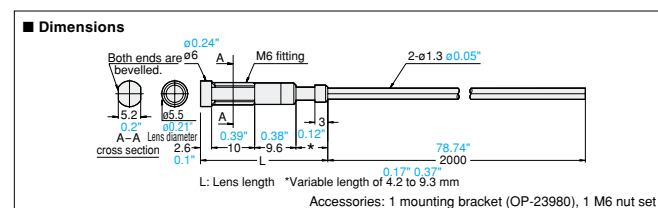

Install in cramped locations.

### Side-view type CZ-11

#### Specifications

Detection range	3 to 15 mm 0.12" to 0.59"
Beam spot diameter	ø0.9 to ø1.5 mm ø0.04" to ø0.06"

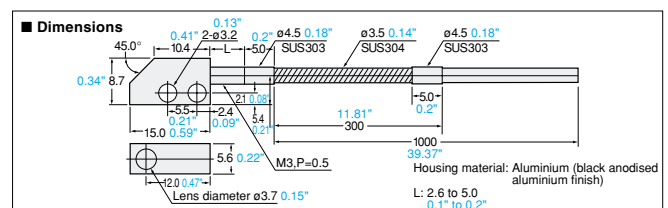



Digital amplifier  
CZ-K1

# CZ SERIES

## For detecting tinted transparent objects. ■ ■ ■ for transparent objects

The CZ Series of sensors can differentiate among transparent objects with only slight color differences due to its combination of the principle of recurrent reflection, which sends light through the workpiece twice and increases the light's attenuation, with a proprietary KEYENCE optical system and the sensor's high-precision detection capability that results from its separate RGB light sources.

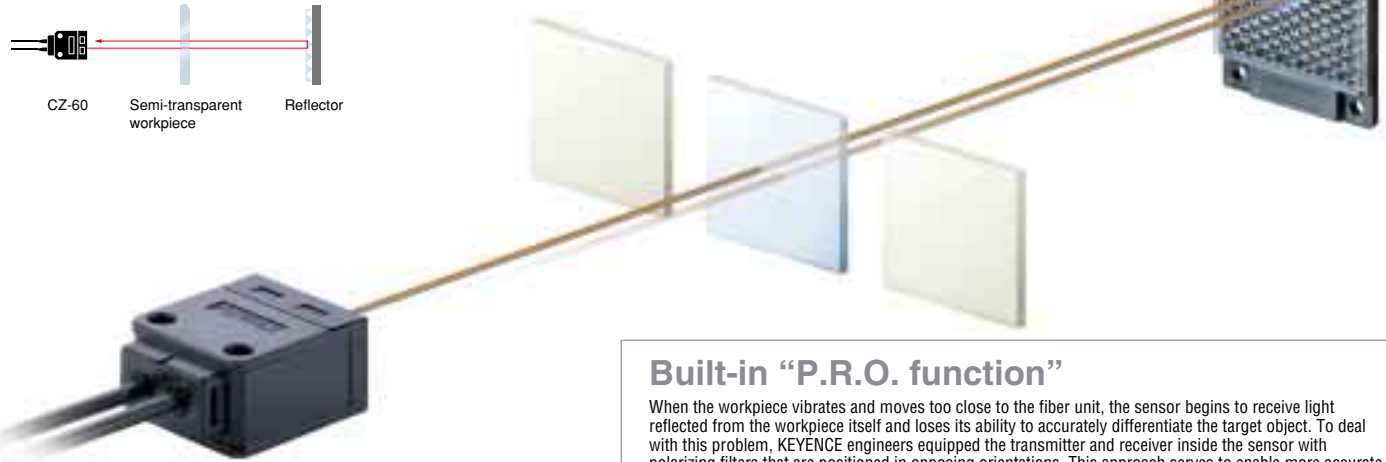

Recurrent reflective type unit for transparent object differentiation

### CZ-60 **NEW**

■ Specifications

Detection range	40 to 1,000 mm 1.57" to 39.37" (when using the R-2 reflector)
Aperture angle	Approx. 10°

### Built-in "P.R.O. function"

When the workpiece vibrates and moves too close to the fiber unit, the sensor begins to receive light reflected from the workpiece itself and loses its ability to accurately differentiate the target object. To deal with this problem, KEYENCE engineers equipped the transmitter and receiver inside the sensor with polarizing filters that are positioned in opposing orientations. This approach serves to enable more accurate differentiation of the target object by limiting the type of light that can be received.

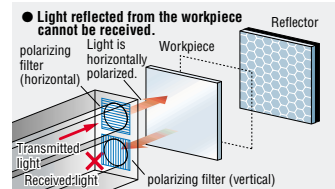

Light that has been horizontally polarized at the transmitter cannot pass through the vertically oriented polarizing filter even if it is reflected from the workpiece before reaching the reflector.

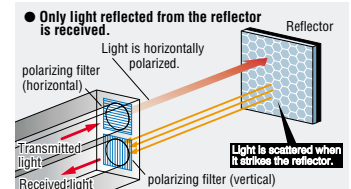

Light is scattered as it strikes the reflector, allowing it to be received regardless of the orientation of the polarizing filter.

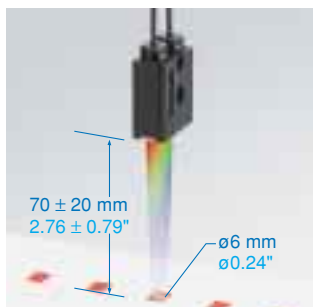

Long-distance waterproof type boasts a 70-mm 2.76" detection range.

### Waterproof long-range beam spot type CZ-40

■ Specifications

Detection range	70 ± 20 mm 2.76" ± 0.79"
Beam spot diameter	ø 6 mm ø 0.24"
Enclosure rating	IP67

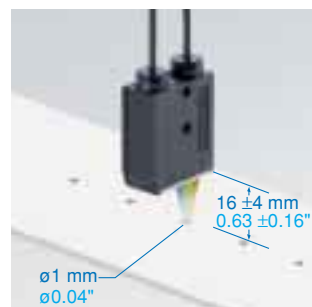

Small beam spot type for locations exposed to water.

### Waterproof small beam spot type CZ-41

■ Specifications

Detection range	16 ± 4 mm 0.63" ± 0.16"
Beam spot diameter	ø 1 mm ø 0.04"
Enclosure rating	IP67

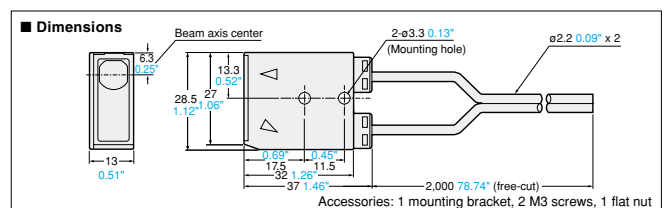
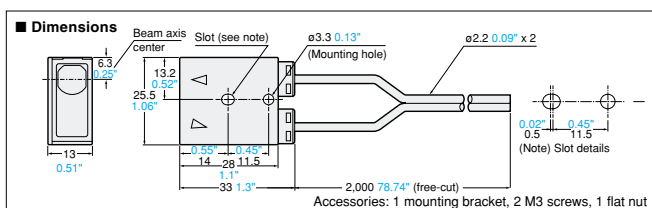

\*The beam spots portrayed in product photographs are simulated illustrations and as such differ from actual beam spot appearance.

# Three light sources enable high-grade amplifier performance.

The CZ Series uses a new detection system that differentiates target objects using 3-color RGB light. This innovative technology offers compatibility with a wide range of applications, including minute detection and color differentiation, that result in unreliable detection with traditional sensors whose operation is based on detecting differences in the amount of light received.

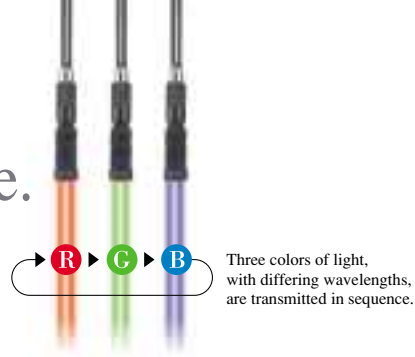

## Detection based on relative RGB ratios means more reliable, stable sensor operation.

[Case 1] ■ Compatible with colors where differentiation with single-colored light is impossible.

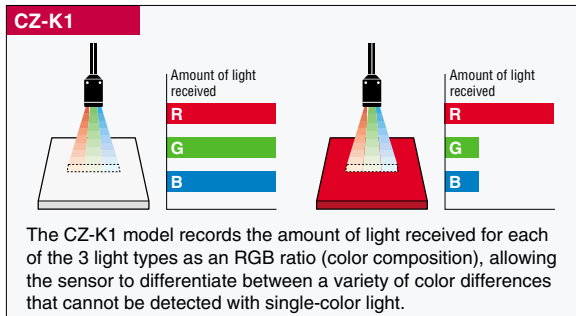
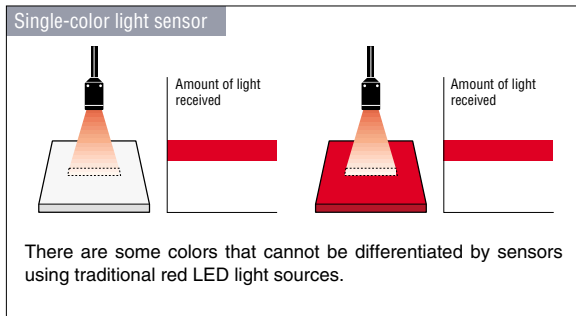

[Case 2] ■ Provides stable, reliable detection even when the workpiece is subject to vibration.

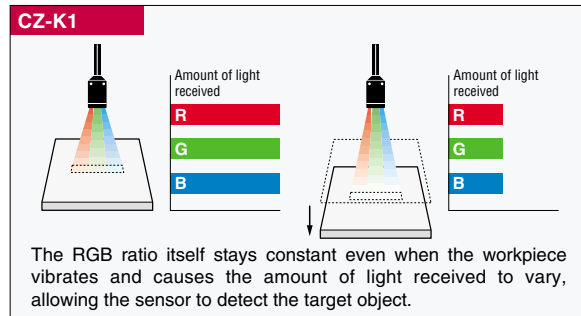
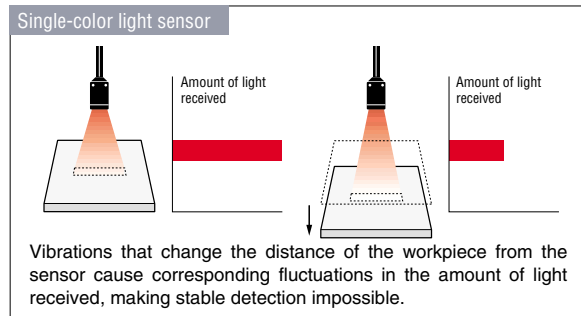

## KEYENCE's commitment to usability brings you simple, intuitive operation.

### ■ One-touch sensitivity configuration.

Configuring sensitivity is a simple process, requiring only that you press the "SET" button once for the workpiece you want to detect. The sensor immediately recognizes the target object's signature color composition. (In 1-point tuning mode)



### ■ Understand differentiation status at a glance with the 2-color display.

The sensor's display changes colors to indicate ON and OFF status, informing you of its differentiation status at a glance.



## Compatible with the wire-saving One Line system.

### ■ Simple wiring even when using multiple units.

The CZ Series offers compatibility with the popular, wire-saving One Line system. For applications requiring the simultaneous use of multiple amplifiers, power can be supplied to additional amplifiers from the connector on the side of the unit. This convenient system eliminates the need for power lines for other sensors that are used at the same time, providing a dramatic reduction in the amount of labor consumed by configuring device wiring.

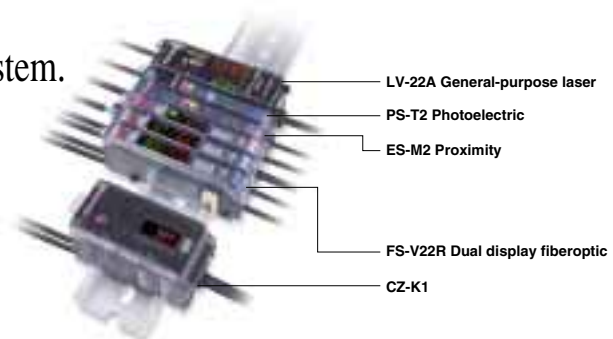



## Part Names



- 1. **DIP switch**  
Switch various settings
- 2. **Timer selection switch**  
Select timer-off or 40-ms off-delay
- 3. **Output indicator**
- 4. **External synchronous input indicator**
- 5. **Tuning display light**
- 6. **UP/DOWN key**  
Adjustment of setting value
- 7. **LCD display monitor**  
Displays matching rate, received light quantity, and setting value
- 8. **MODE selection switch**  
Switching settings value and present value
- 9. **SET button**  
Setting sensitivity
- 10. **Output selection switch**  
N.O. matching output  
N.C. non-matching output

## CZ AMP PERFORMANCE

### Built-in high-precision, triple 12 bit A/D converter

**12bit**  
triple A/D

The amount of light received for each of the 3 RGB colors is detected at a 12-bit resolution, enabling the amplifier to perform calculations using actual 36-bit data and making it the industry's highest-resolution calculation system. The end result is enhanced stability for previously difficult detection applications.

### High-speed 300 μs response

The amplifier includes a 300 μs high-speed response mode. As a concrete example of the speed provided by this response, the system is capable of detecting marks that are 1 mm 0.04" wide on sheeting being fed at a speed of 3.3 m/s. (HSPD = during high-speed mode operation)

### Built in self-stabilizer

The self-stabilizer monitors variations in the amount of light produced by the LED and operates to maintain light transmission at a constant and uniform level, cancelling the effects of temperature fluctuations and the passage of time on the efficiency of the transmitter LED.

### Eight-color registration and external tuning feature

The "8-bank switching" feature allows you to store 8 settings in the amplifier's memory and switch among them using an external signal generated by a device such as a PLC. There is also an "external tuning" feature that lets you use an external device such as a push-button to trigger SET operation. These features combine help to smooth changes in production line configuration.

Red light source  
Blue light source  
Green light source

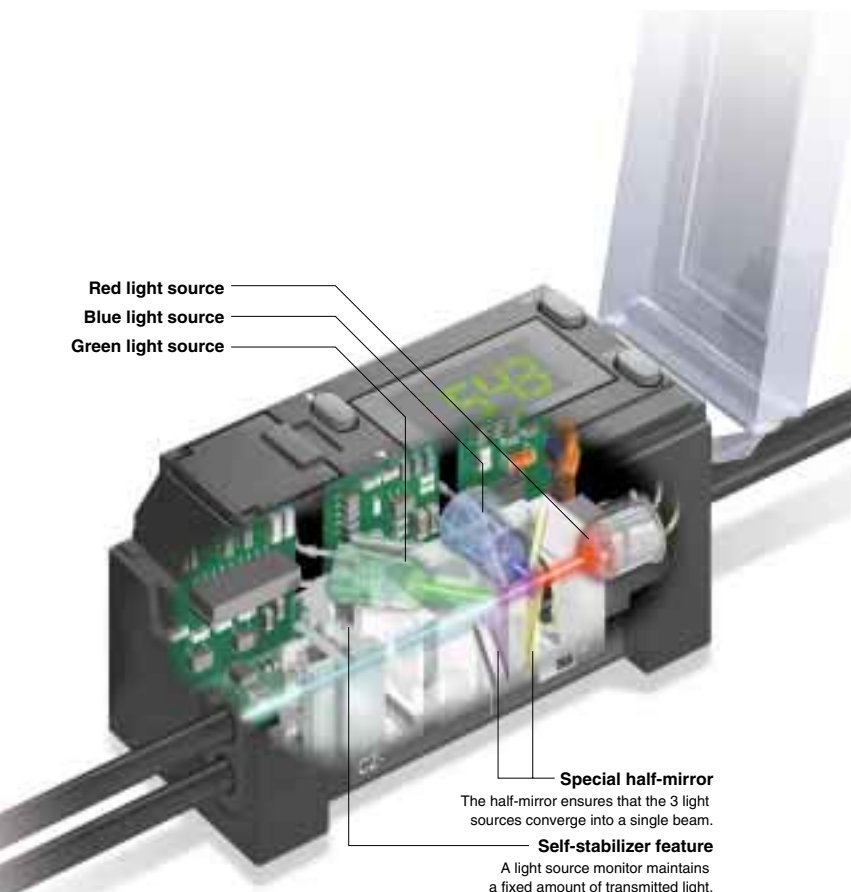

## Sensor installation techniques

### Basic settings

#### Tuning

When the sensor is required to differentiate between 2 colors, use 2-point tuning; use 1-point tuning for all other applications.

#### Differentiation mode

- Incline the sensor 10 to 15° for reflective type setups in order to avoid the influence of workpiece surface gloss. For recurrent reflective setups, install the sensor and its reflector so that the amount of light received in I mode is as high as possible.
- Set the sensor to C mode and adjust its sensitivity.
- If you cannot achieve stable detection using C mode, set the sensor to C+I mode and adjust its sensitivity.
- Reinstall the sensor so that the amount of light received in I mode falls within the range of 2,000 to 3,000 if the display reads "UUU". Reinstall the sensor so that the amount of light received in I mode increases if the display reads "nnn" or if you are experiencing unstable detection.

#### DIP switch

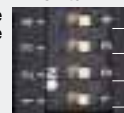

- 11. **Detection mode switch**  
Fine (high accuracy) mode  
HSPD (high speed) mode
- 12. **Calibration mode switch**  
One-point or two-point tuning
- 13. **Differentiation mode switch (C/C+I)**



#### I mode

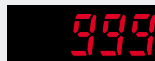

#### C, C+I mode

Mode	Switch	Description
C (Color)	<input type="checkbox"/> <input checked="" type="checkbox"/>	Detects color using RGB colour components.
C + I (Color and intensity)	<input checked="" type="checkbox"/> <input type="checkbox"/>	Detects color using RGB colour components and received light intensity.
I (Intensity)	<input type="checkbox"/> <input checked="" type="checkbox"/>	Detects color using received light intensity.

### When workpiece color varies

- First perform 1-point tuning using the background and adjust the sensor's sensitivity. (In the example detection application to the right, the bottom of the part feeder serves as the background.)
  - Set the output selection switch to "N.C."
- (This configuration will detect all objects that differ from the background, including parts whose color varies.)



<Detection of parts in a part feeder>

### When differentiating among multiple colors

#### Bank switching allows settings for up to 8 colors to be registered.

- Perform 1-point tuning for each bank for the color that you want it to detect.
- Use a PLC to implement high-speed bank switching as the workpieces pass the fiber unit and use the output timing to differentiate workpiece color.

#### Time chart

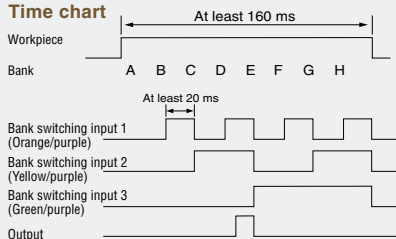

<Differentiation of cap color>

\* An interval of 20 ms is necessary between bank switching and output.  
\* The usage of 8 banks requires a total time of at least 20 X 8 = 160 ms for differentiation.

#### <How to switch among registered colors using external input>

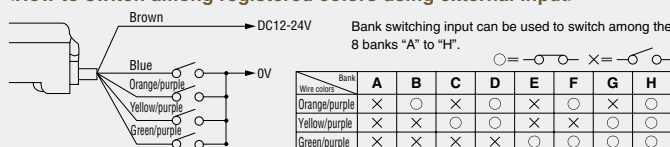

# A variety of fiber units provides compatibility with a range of applications.

## <The automotive and metals industries>



### Detection of die inserts

The CZ Series provides reliable differentiation of minute color variations such as the difference between gold and silver that are difficult to detect with traditional sensors that operate based on the amount of light received, making it suitable for applications such as the detection of brass die inserts. Since long-distance detection is available, the sensor can be positioned at distance from the die itself.

[Recommended fiber unit]

**CZ-40** (70±20 mm 2.76°±0.79° long-range type)

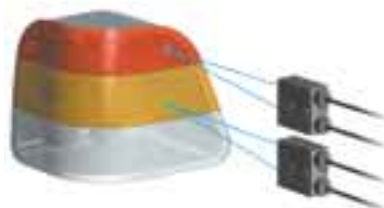

### Differentiation of tail lamp type

The sensor differentiates among various designs, such as different product types, overseas versions, etc., by recognizing differences in their color compositions. This setup adapts easily to changes in production line configuration thanks to the external tuning feature, which allows 8-color registration and SET operation to be controlled by external input. Thanks to a 70±20 mm 2.76°±0.79° detection range, stable detection is not compromised by variations in the distance between the sensor and the workpiece.

[Recommended fiber unit]

**CZ-40** (70±20 mm 2.76°±0.79° long-range type)

## <The food and pharmaceutical industries>

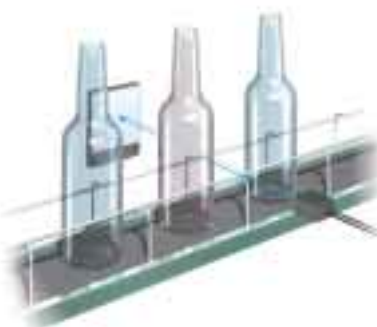

### Differentiation of transparent bottle product type

In a recurrent reflective type configuration, the beam of light passes through the workpiece twice, differentiating between even slight differences in color. Because the sensor includes a P.R.O. feature that eliminates the influence of light reflected from the workpiece surface, the system provides stable and reliable detection even when there are variations in workpiece position. The use of bank switching for 8 color registrations simplifies production line configuration changes.

[Recommended fiber unit]

**CZ-60** (Recurrent reflective type)



### Differentiation of can orientation

The sensor recognizes the point you want to detect by its color composition, differentiating the difference in color when workpiece orientation is reversed. Because detection is based on color composition, the system is insulated from the influence of the curved workpiece surface. In addition, the sensor's high-speed 300-μs response in HSPD mode makes it capable of detecting fast-moving workpieces.

[Recommended fiber unit]

**CZ-40** (70±20 mm 2.76°±0.79° long-range type)



### Detection of bottle cap liners

The sensor can detect whether a bottle cap liner is present by differentiating between the color of the cap and that of the cap liner. The long-range CZ-40 can be installed up to 70 mm 2.76° away from the target objects and features an IP-67-rated waterproof construction.

[Recommended fiber unit]

**CZ-40** (70±20 mm 2.76°±0.79° long-range type)



### Detection of adhesive application

Because it detects target objects based on their color composition, the sensor also provides stable and reliable detection of adhesives, which are difficult to detect with traditional sensors that operate based on the amount of light received. Further, detection stability is not compromised by slight variations in range caused by the flexibility of the paper boxes.

[Recommended fiber unit]

**CZ-40** (70±20 mm 2.76°±0.79° long-range type)

## <The printing and packaging industries>



### Detection of stickers on cardboard boxes

The sensor detects the difference between the cardboard box and the sticker. Once the sensor has been configured for the cardboard box with 1-point tuning, it differentiates all other objects that differ in color. The CZ-40's detection range of 70±20 mm 2.76°±0.79° also makes it suitable for use with workpieces that are subject to vibration.

[Recommended fiber unit]

**CZ-40** (70±20 mm 2.76°±0.79° long-range type)

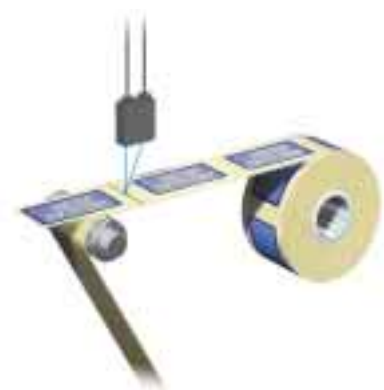

### Detection of sticker label tape seams

By recognizing only the tape seam by its color composition, the sensor is able to detect the seam while ignoring the colorful stickers. And because the sensor is not easily affected by variations in distance, the setup is also compatible with applications where the stickers are subject to vertical vibration.

[Recommended fiber unit]

**CZ-41** (Small 1.0-diameter beam spot type)  
For long range applications: CZ-40

### <The semiconductor and electronics industries>

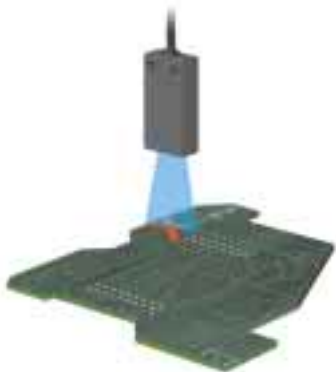

#### Detection of reject marks on circuit boards

All you have to do to adjust the sensor's sensitivity is align the sensor with the board's color and press the "SET" button once. The sensor will recognize the color composition instantly and automatically adjust its sensitivity (1-point tuning). The area spot provides stable, reliable detection even if the position and shape of the reject mark varies.

#### [Recommended fiber unit]

**CZ-12 (Area spot type)**

For long range applications: CZ-40

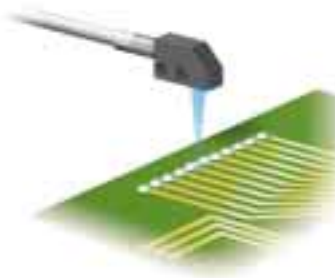

#### Detection of solder bridges on circuit boards

The sensor differentiates between the color of the circuit board and the color of the solder. For best results, position the sensor at a point that is particularly prone to this defect. Because the beam spot diameter can be adjusted between 0.9 0.04" and 1.5 mm 0.06" in diameter by changing how far the fiber is inserted, the sensor's sensitivity can be fine-tuned after installation.

#### [Recommended fiber unit]

**CZ-11 (Variable small beam spot/side-view type)**

When you want a larger range for beam spot diameter adjustment: CZ-10



#### Detection of wafer surface finish

The sensor recognizes color composition variations to detect the minute difference in the surface conditions of wafers before and after film coating. Since the sensor is compatible with long-range detection at up to 70±20 mm 2.76±0.79", space surrounding the wafers can be kept free.

#### [Recommended fiber unit]

**CZ-40 (70±20 mm 2.76±0.79" long-range type)**



#### Differentiation of the orientation of tiny chips

The sensor can be made to detect differences in the orientation of tiny chips by adjusting the beam spot so that it falls in the center of the embossed area of the chips. Since the beam spot size can be varied between 0.9 0.04" and 1.5 mm 0.06" in diameter, the sensor can be adjusted to match workpiece conditions. And since the CZ Series uses color composition rather than the amount of light received to detect target objects, the setup is compatible with slight changes in target object position and even with workpiece vibration.

#### [Recommended fiber unit]

**CZ-11 (Variable small beam spot/side-view type)**  
For detection ranges of 15 mm 0.59" and greater: CZ-10

### <The electrical and precision equipment industries>

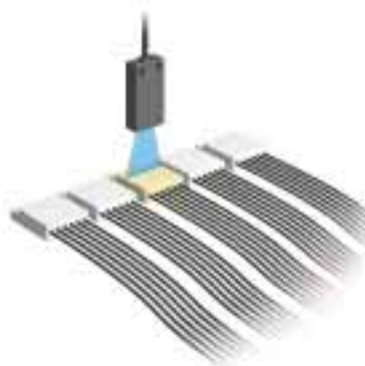

#### Differentiation of connector type

Because it recognizes the target area by its color, the sensor is capable of minute color differentiation even if there is some warp in the housing case. This setup adapts easily to changes in production line configuration thanks to the external tuning feature, which allows 8-color registration and SET operation to be controlled by external input.

#### [Recommended fiber unit]

**CZ-12 (Area spot type)**

For long range applications: CZ-40



#### Detection of tape leader

Because the CZ-40 is capable of long-range detection of 70±20 mm 2.76±0.79" and is resistant to vibration, it can provide stable detection of tape leaders even when the tape reel diameter changes. This setup offers reliable differentiation because it recognizes the minute difference in color composition between the transparent leader and the end of the tape.

#### [Recommended fiber unit]

**CZ-40 (70±20 mm 2.76±0.79" long-range type)**



#### Detection of insulating caps on alkaline batteries

The variable beam spot of 0.9 to 3.5 mm 0.04 to 0.14" diameter can be fine-tuned, allowing it to be reliably aimed at the tiny gap into which the insulating caps fit. Since the sensor recognizes target objects using their color composition, minute differentiation is also possible. The sensor's high-speed 300-μs response also provides compatibility with high-speed production lines.

#### [Recommended fiber unit]

**CZ-10 (Variable small beam spot/straight type)**



#### Detection of remaining wire on a bobbin

Once the sensor has been programmed with the bobbin's color, it can detect the part of the bobbin that has become visible. Since the sensor recognizes only the bobbin by its color composition, the setup provides stable and reliable detection even in the presence of vibrations.

#### [Recommended fiber unit]

**CZ-40 (70±20 mm 2.76±0.79" long-range type)**



## Dimensions

### CZ-K1/K1P amplifier unit when mounted to DIN rail

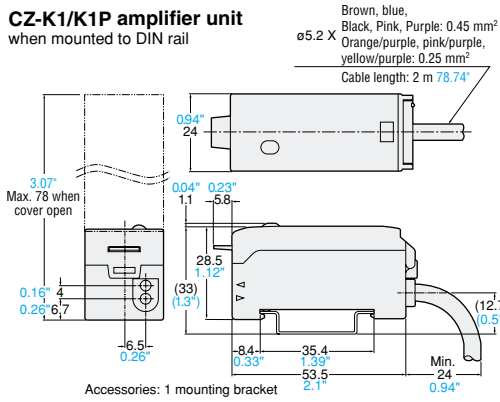

Brown, blue, Black, Pink, Purple: 0.45 mm<sup>2</sup>  
Orange/purple, pink/purple, yellow/purple: 0.25 mm<sup>2</sup>  
Cable length: 2 m 78.74"

### CZ-60 fiber unit

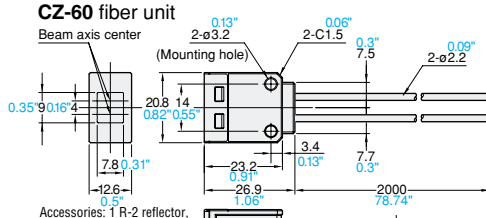

### CZ-12 fiber unit

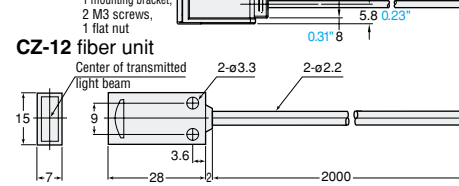

### Mounting bracket (CZ-60 accessory)

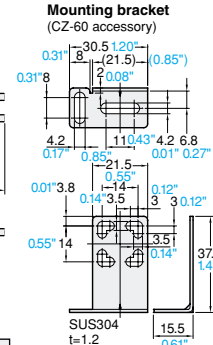

### R-2 reflector (CZ-60 accessory)

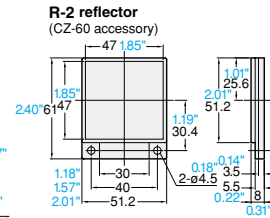

### Flat nut (CZ-60 accessory)

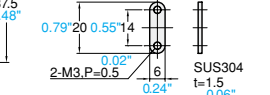

## Connections

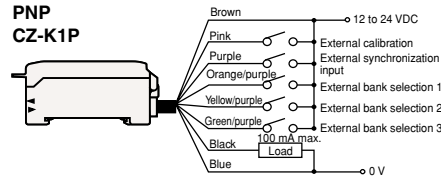
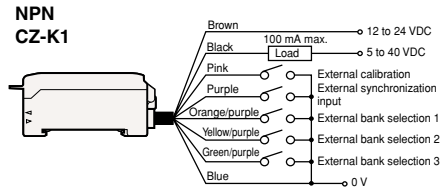

## Input/Output Circuits

### Output circuit NPN CZ-K1

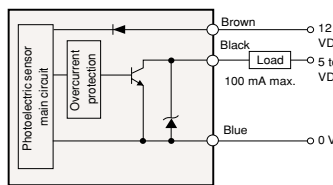

### PNP CZ-K1P

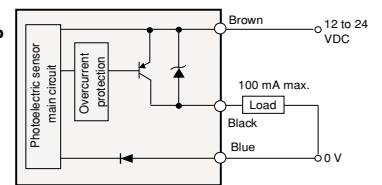

### Input circuit

External calibration input  
External synchronization input  
External bank selection input 1 to 3

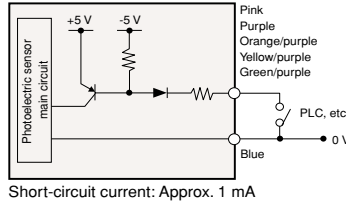

External calibration input  
External synchronization input  
External bank selection input 1 to 3

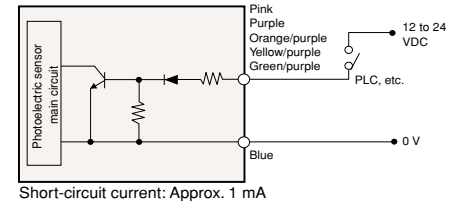

## Specifications

Model	NPN		CZ-K1	
	PNP		CZ-K1P	
Light source	Red LED, Green LED, Blue LED			
Response time	300 μs/1 ms (switch-selectable)			
Indicators	Output: Red LED, Calibration: Orange LED, External synchronization input: Green LED, Matching rate/received light intensity: LCD (Red/Green)			
Error indication	Excess light intensity, insufficient light intensity, insufficient color difference			
Calibration method	1-point/2-point calibration (switch-selectable)			
Tolerance value adjustment	Numerical value setting on digital display			
Differentiation mode	C mode/C + 1 mode/l mode (switch-selectable)			
Timer function	OFF-delay timer (40 ms)/Timer OFF (switch-selectable)			
Output selection	Match output: Turns on when target color matches registered color. Mismatch output: Turns on when target color is different from registered color. (switch-selectable)			
External synchronization input	Non-voltage input, Response speed: 500 μs max.			
External calibration input	Non-voltage input, Input response time: 20 ms min.			
Registered color selection	8-bank selection (By external input), Non-voltage input, Input response time: 20 ms min.			
Control output	NPN or PNP: 40 VDC max. (100 mA max.), Residual voltage: 1.0 V max.			
Protection circuit	Reverse-polarity protection (power supply), overcurrent protection (output), surge absorber (output)			
Power supply	12 to 24 VDC ±10%, Ripple (P-P): 10% max.			
Current consumption	75 mA max.			
Ambient light	Incandescent lamp: 5,000 lux max., Sunlight: 10,000 lux max.			
Ambient temperature	-10 to +55°C (14 to 131°F), No condensation			
Relative humidity 1.	35 to 85%, No condensation			
Housing material	Polycarbonate			
Weight (including 2-m 6.6' cable)	Approx. 115 g			

- When several units are connected, the acceptable ambient temperature varies depending on the conditions given below. To connect several units, be sure to mount them to a DIN rail (metallic plate). Ensure that the output current is 20 mA max.
  - When 3 to 10 units are connected: -10 to +50°C (14 to 122 °F)
  - When 11 to 16 units are connected: -10 to +45°C (14 to 113 °F)

Visit our website for other KEYENCE products at [www.keyence.com](http://www.keyence.com)

Specifications are subject to change without notice.

# KEYENCE

KEYENCE CORPORATION OF AMERICA

Corporate Office

50 Tice Blvd., Woodcliff Lake, NJ 07677, U.S.A. Phone:201-930-0100 Fax:201-930-2255

**Boston Office**  
Phone:781-453-2244 Fax:781-453-2255

**Atlanta Office**  
Phone:770-951-1222 Fax:770-951-1958

**Cincinnati Office**  
Phone:513-554-1227 Fax:513-554-1229

**Minneapolis Office**  
Phone:952-924-9779 Fax:952-249-9143

**Phoenix Office**  
Phone:602-225-2400 Fax:602-225-2425

**New Jersey Office**  
Phone:201-474-1480 Fax:201-474-1481

**Tampa Office**  
Phone:813-998-9886 Fax:813-998-9887

**Michigan Office**  
Phone:734-591-9922 Fax:734-591-1722

**St. Louis Office**  
Phone:314-275-9174 Fax:314-275-9175

**Portland Office**  
Phone:503-699-0500 Fax:503-699-8400

**Pennsylvania Office**  
Phone:610-768-8993 Fax:610-337-1067

**Cleveland Office**  
Phone:216-464-7530 Fax:216-464-7540

**Indianapolis Office**  
Phone:317-843-2616 Fax:317-843-2647

**Texas Office**  
Phone:972-733-6790 Fax:972-733-6791

**Northern California Office**  
Phone:925-225-1550 Fax:925-225-1440

**Charlotte Office**  
Phone:704-423-0070 Fax:704-423-0066

**Columbus Office**  
Phone:614-799-3400 Fax:614-799-3401

**Chicago Office**  
Phone:847-969-0001 Fax:847-969-0453

**Denver Office**  
Phone:303-756-5242 Fax:303-756-8301

**Los Angeles Office**  
Phone:562-552-9980 Fax:562-552-9981